

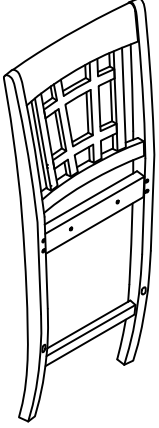

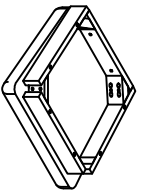
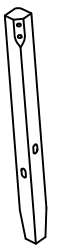

ASSEMBLY INSTRUCTIONS

Description: Waylon II Stool
Item No.: TN-4560ST

LIST OF PARTS

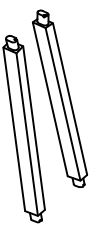
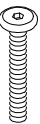
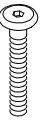
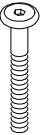
A Chair back				1 pc
B Seat Frame				1pc
C Front legs				1L; 1R
D Front stretcher				1pc
E Side stretcher				1L; 1R
HARDWARE LIST				
1 Short bolt		2 Long bolt		
1/4" x 40mm(2 pcs)		1/4" x 60mm(4 pcs)		
3 Long bolt		4 Spring washer		
1/4" x 85mm(4 pcs)		1/4" (10 pcs)		
5 Flat washer		6 Screws		
1/4" x 19(10 pcs)		#8 x 38mm(6 pcs)		
7 Allen key				
4mm(1 pc)				

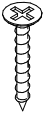
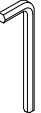
Step. 1

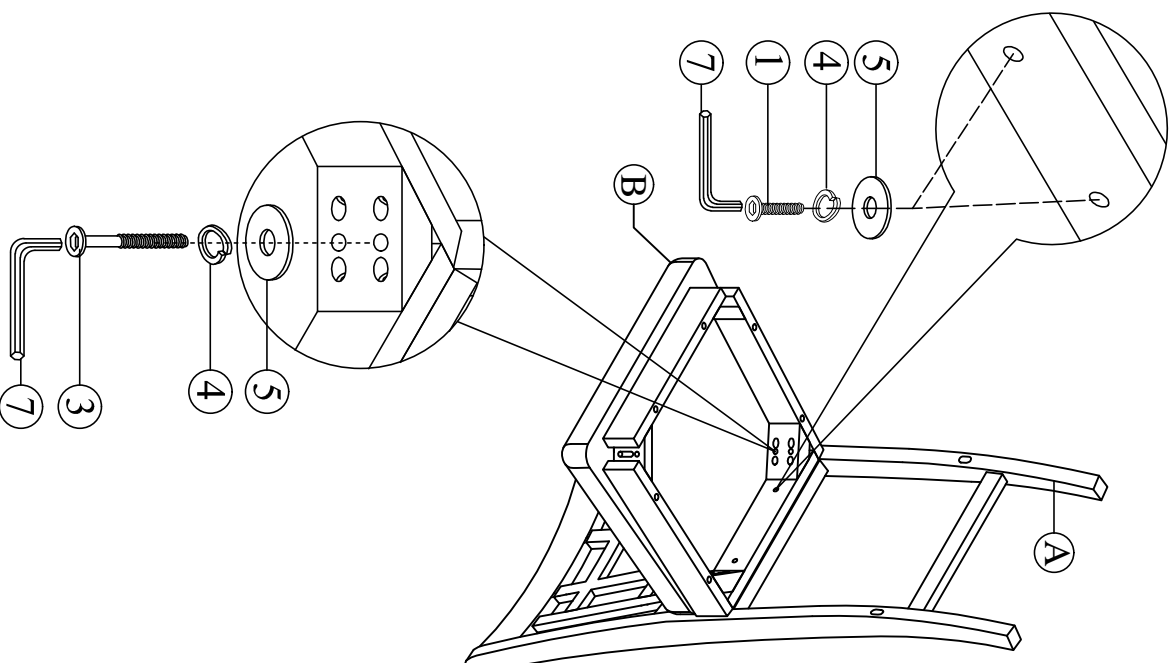

Step. 2

