







# ASSEMBLY INSTRUCTIONS

ITEM #: S107-D/S107-M  
DRESSER/MIRROR

## PART LISTS LISTA DE PARTES

NO.	DESCRIPTION	SKETCH	Q'TY
(A)	DRESSER		1PC
(B)	MIRROR		1PC
(C)	BACK RAIL		2PCS

## HARDWARE LISTS LISTA DE TORNILLO

NO.	DESCRIPTION	SKETCH	Q'TY
(1)	ALLEN BOLT (Ø1/4"*1-1/2")		8PCS
(2)	LOCK WASHER (Ø1/4")		8PCS
(3)	LOCK WASHER (Ø1/4")		8PCS
(4)	ALLEN KEY (4mm)		1PC

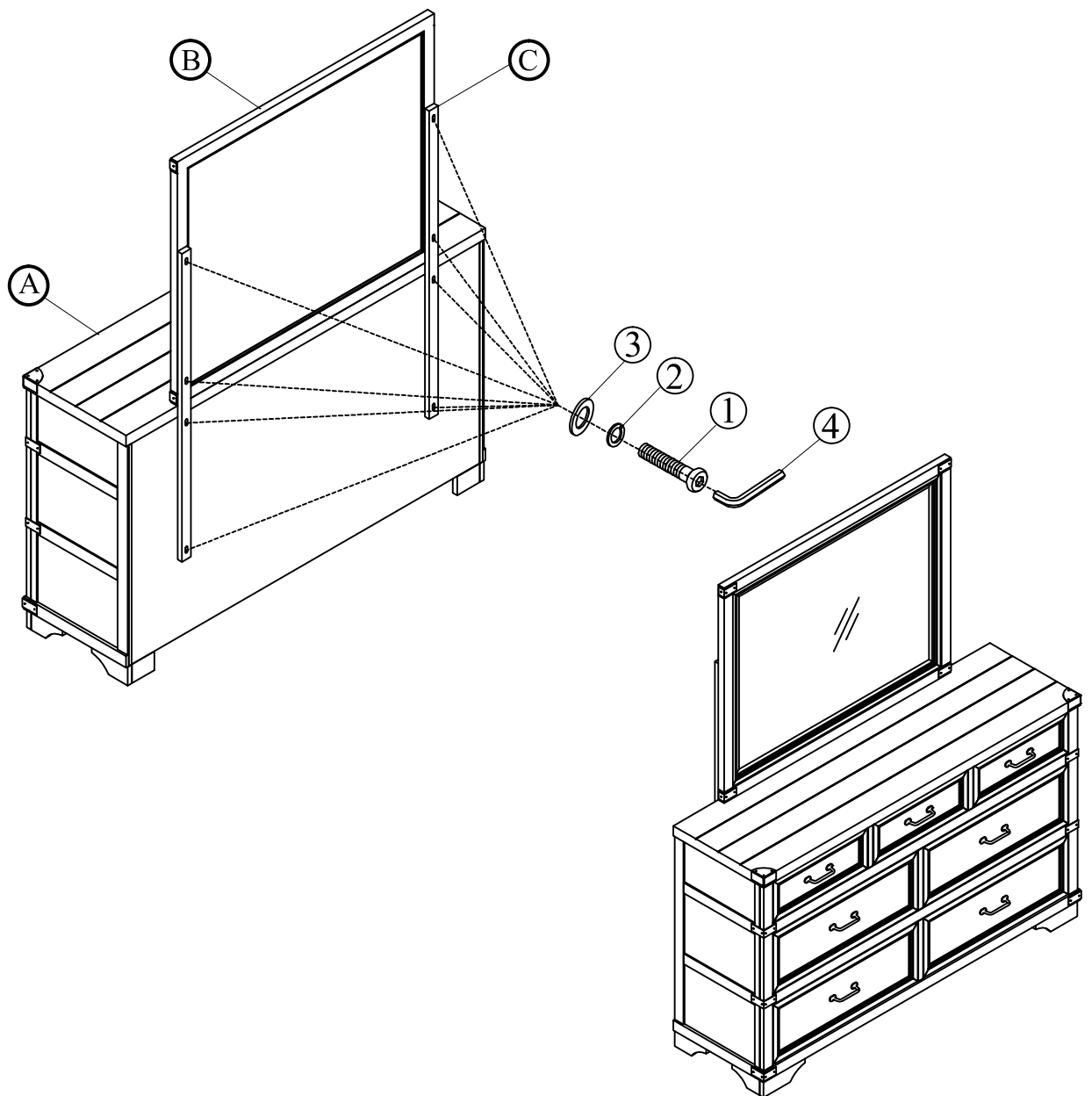

Completed

MADE IN VIETNAM

PAGE 2 OF 2