

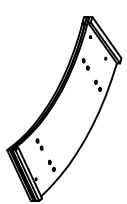

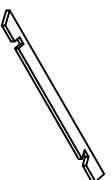

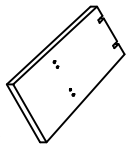
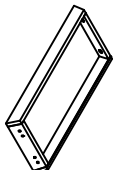

ASSEMBLY INSTRUCTIONS

Description: TRIANGLE 2 BENCH BROWN PU
Item No: DC597- BENCH

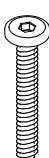
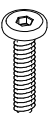
LIST OF PARTS

A. Cushion 1pc 	B. Seat panel 1pc 	C. Support Rail 2pcs 
D. Side Leg 2pcs 	E. Connection Frame 1pc 	

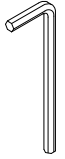
LIST OF HARDWARE

1. Bolt  Ø5/16" x 50mm (8pcs)	2. Bolt  Ø5/16" x 40mm (8 pcs)
3. Spring Washer  Ø5/16" (16pcs)	4. Flat Washer  Ø5/16" x 19mm (16 pcs)
5. Plastic Cap  Ø20 x 6mm (4 pcs)	6. Allen Key  4mm(1pc)
7. Wood Dowel  Ø8 x 30mm (8 pcs)	

Step.1

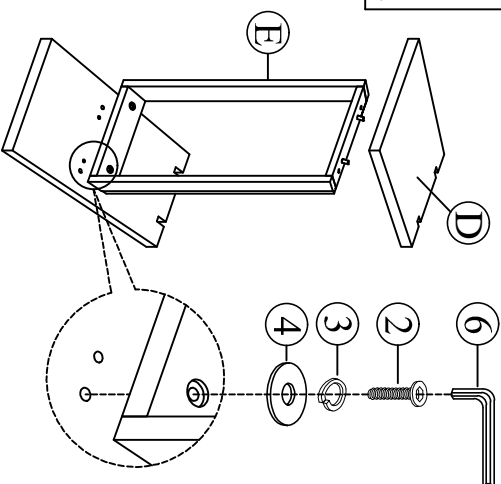

Step.2

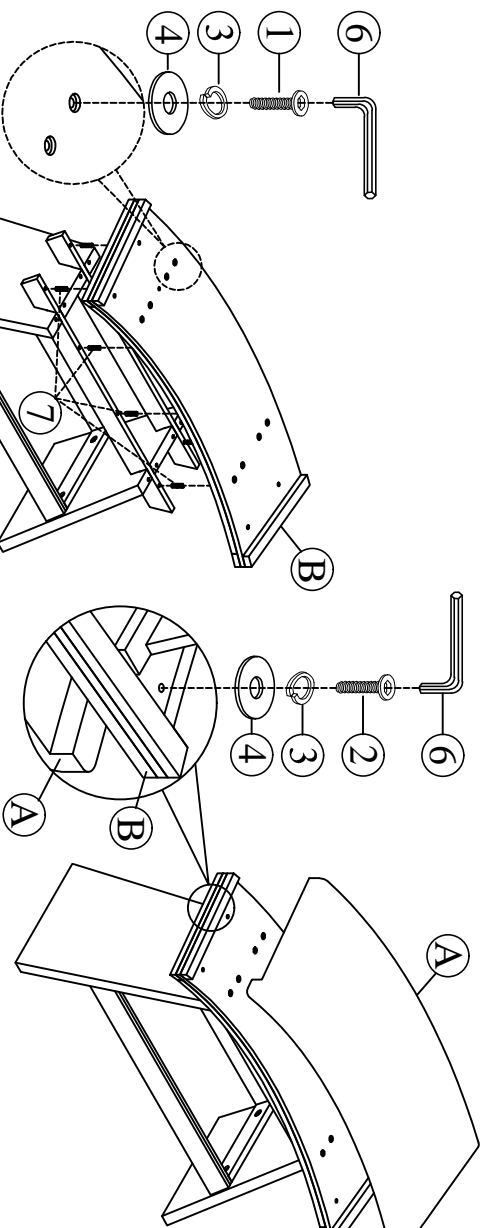

Step.3

