

SOHO

## ASSEMBLY INSTRUCTIONS

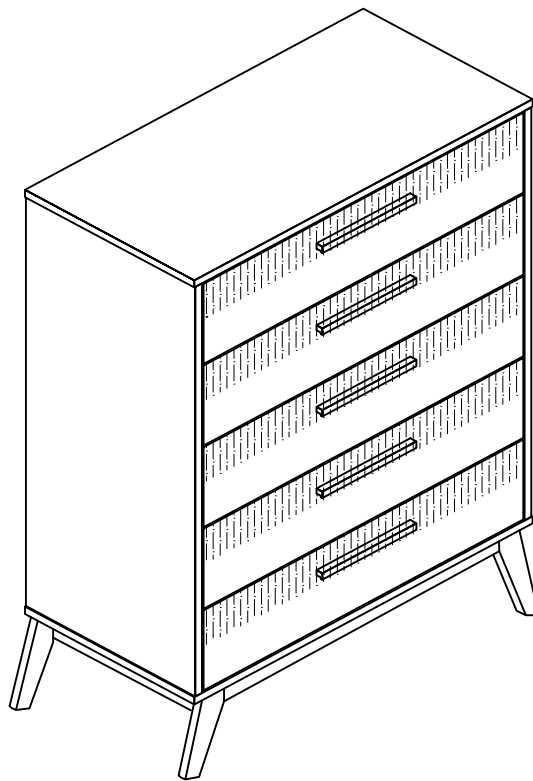





# SOHO

## FIVE DRAWER CHEST

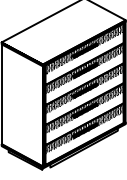

- \* Always use proper tools.
- \* Follow the assembly steps in order. Do not skip any steps.
- \* Be sure to check all packing materials carefully for small parts may have come loose inside the carton during shipment. If parts are missing, contact the retailer from which you purchased the product to obtain any missing parts. **DO NOT USE SUBSTITUTE PARTS.**
- \* Periodically check to ensure that all connectors (bolts, screws, etc.) are tight.
- \* Keep the instructions for future reference.
- \* Some assembly may involve attaching glass or mirrors. Be very careful handling the glass or mirrors, as severe injury may result if the glass or mirror breaks. Never handle large pieces of glass or mirrors by yourself.
- \*When assembling products that have electric cords (lamps, light, etc.), always (1) make sure the electrical cord is unplugged before assembly and (2) be careful not to twist the electrical cord during assembly.
- \*When assembling shelves or entertainment centers, do not stand on lower shelves in order to assemble upper shelves—use a step ladder.
- \*Do not stand on tables, including but not limited to, end tables, coffee tables, and dinner tables, as tables are not to support the weight of a person.
- \*Where assembly instructions state that the assembly requires two or more people, do not attempt by yourself as there is a risk of injury.

# SOHO

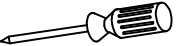
|  |   |   |  |
|--|---|---|--|
| <p><b>A x 8</b></p>  <p>M6 X 60mm</p> | <p><b>B x 8</b></p>  <p>M6</p> | <p><b>C x 8</b></p>  <p>M6</p> | <p><b>D x 1</b></p>  <p>M4</p>                                  |
| <p><b>E x 1</b></p>                   | <p><b>F x 4</b></p>            | <p><b>G x 1</b></p>           | <p>Not Included<br/>No Se Adjunto<br/>Non Indus<br/>不提供此工具</p>  |

- ⚠ NOTE: UNIT SHOULD BE ASSEMBLED BY TWO OR MORE PEOPLE. DO NOT TIGHTEN ANY BOLTS UNTIL ALL BOLTS HAVE BEEN STARTED!
- ⚠ NOTA: ¡ESTA UNIDAD DEBE SER ARMADA POR 2 O MAS PERSONAS! NO APRIETE NINGUN PERNO HASTA QUE TODOS ESTEN EN SU LUGAR!
- ⚠ REMARQUE: LE MEUBLE DOIT ETRE ASSEMBLÉ PAR DEUX PERSONNES OU PLUS. NE BLOQUER AUCUNE VIS TANT QUE VOUS N'AVEZ PAS COMMENCE A TOUTES LES DEMARRER!
- ⚠ 注意：产品应由两个或者两个以上的人员组装。  
在产品组装过程中，不要锁紧螺栓！

