

# POWER LOVESEAT WITH POWER HEADREST

## MODEL SANTA FE

### ASSEMBLY INSTRUCTIONS

IMPORTANT, RETAIN FOR FUTURE REFERENCE: READ CAREFULLY

#### Contents of Cartons

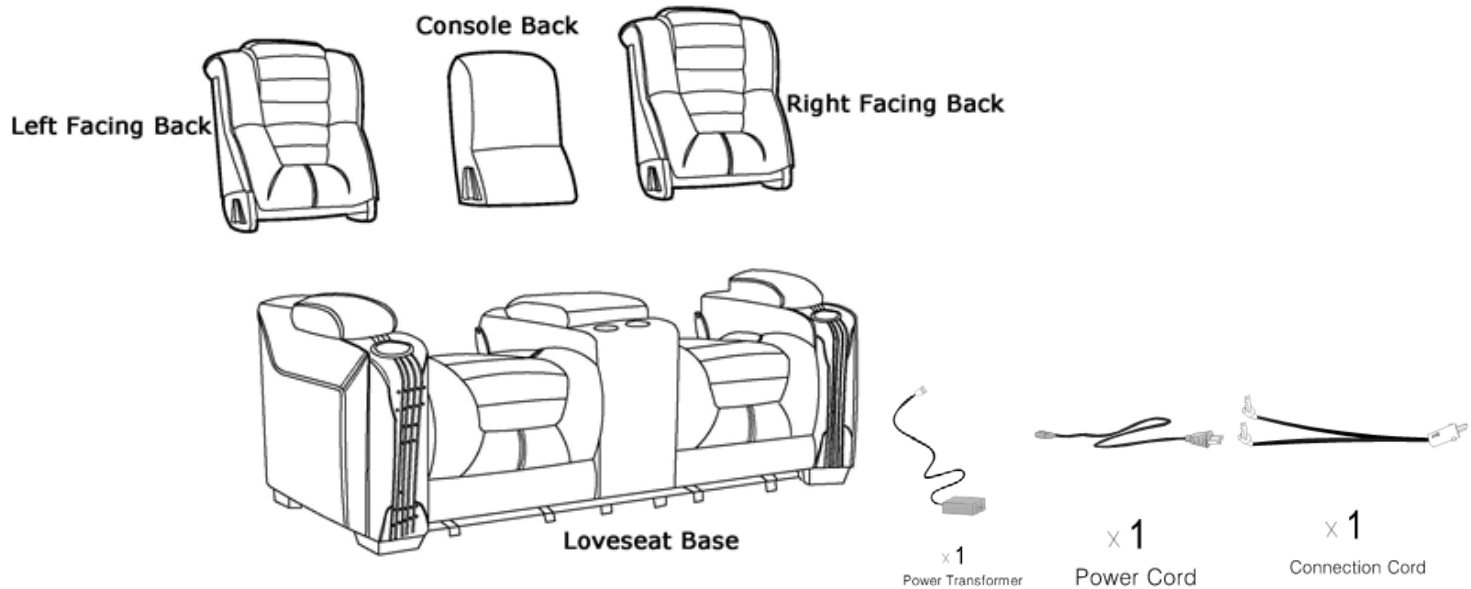

#### Assembly – Console Loveseat

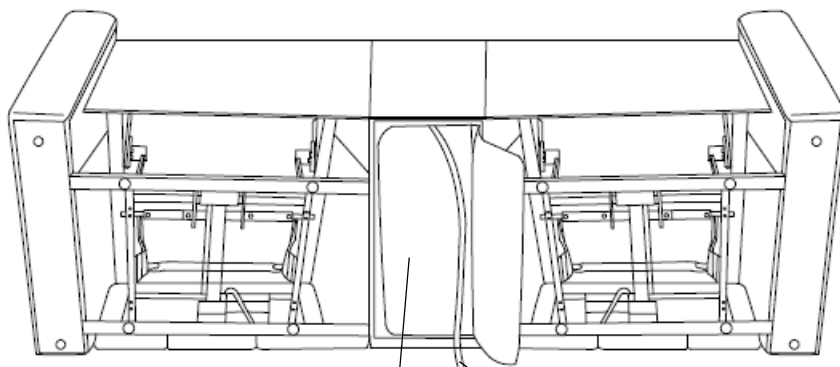

##### Console Back

1. Console Back is packed inside the console base
2. Unzip the dust cover at the bottom of console
3. Pull the strap to remove the console Back from the base
4. Close the dust cover & zipped on.

Step 1: Slide inside back receivers into the steel mechanism posts in the base of the furniture

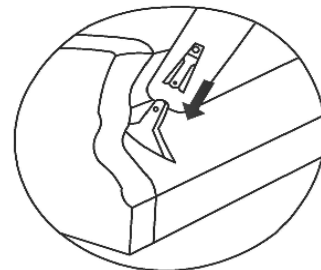

To remove the inside backs, use a screwdriver pressing outward on the black tab in the metal sleeve on both sides of the inside back and lift the inside back from the base of the Furniture

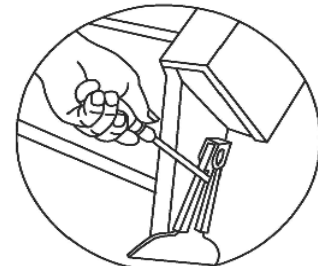

## Electrical Connections

NOTE: The Power Transformer and Power Cord are located under the seats in separate boxes.

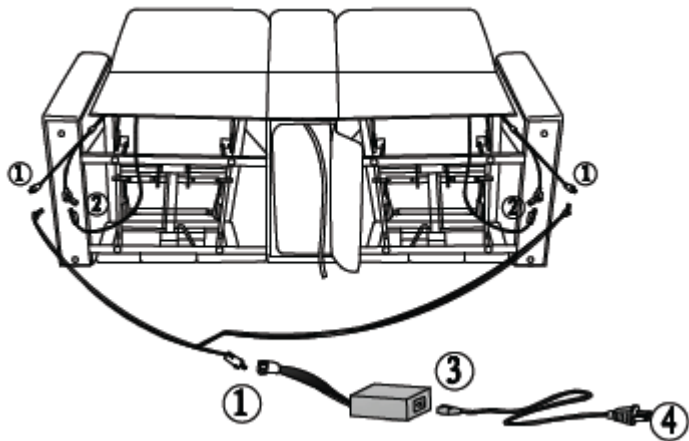

Power Transformer and Cord

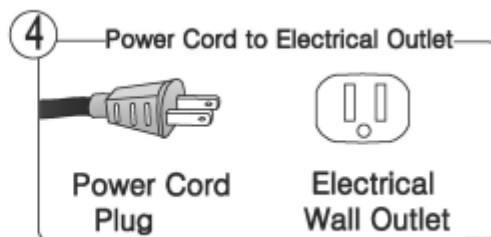
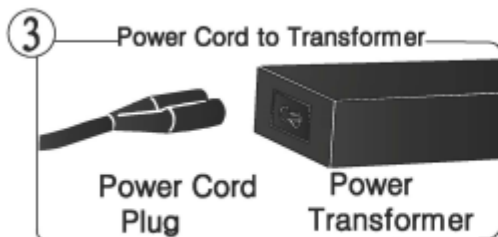
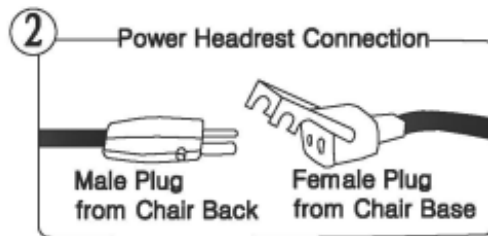
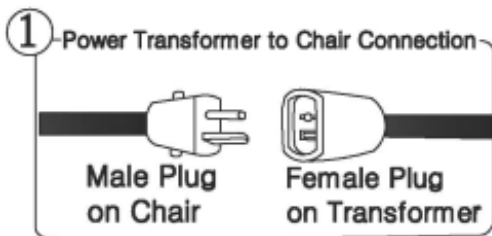

## Electrical Controls

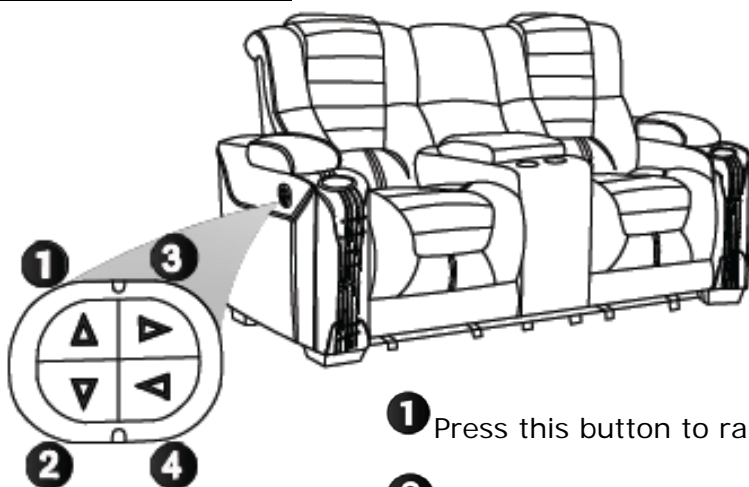

- ① Press this button to raise the headrest up or forward
- ② Press this button to lower the headrest back or down
- ③ Press this button to raise the chair to the upright seated position
- ④ Press this button to recline the chair to your desired position