

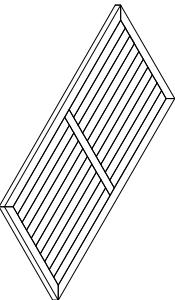

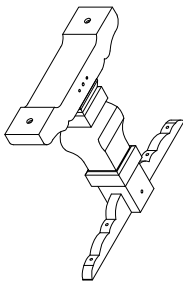

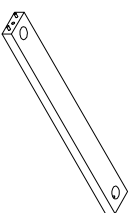

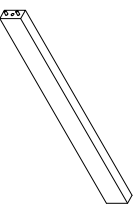

ASSEMBLY INSTRUCTIONS

Group Name: Palisades
 Description: Dining table
 Item No: TN-323-TT & TN-323-TB

LIST OF PARTS

A. Table top  1pc	B. Base leg  2pcs
C. Bottom Stretcher  1pc	D. Top Stretcher  1pc
HARDWARE LIST	
1. Short bolt  5/16" x 50mm(8 pcs)	2. Long bolt  5/16" x 120mm(2 pcs)
3. Bolt  5/16" x 83mm(2 pcs)	4. Spring washer  5/16"(10 pcs)
5. Flat washer  5/16"(10 pcs)	6. Half moon washer  (2 pcs)
7. Hex Nut  5/16"(2 pcs)	8. Spanner  (1 pc)
9. Allen key  4mm(1 pc)	

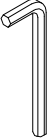
Step. 1

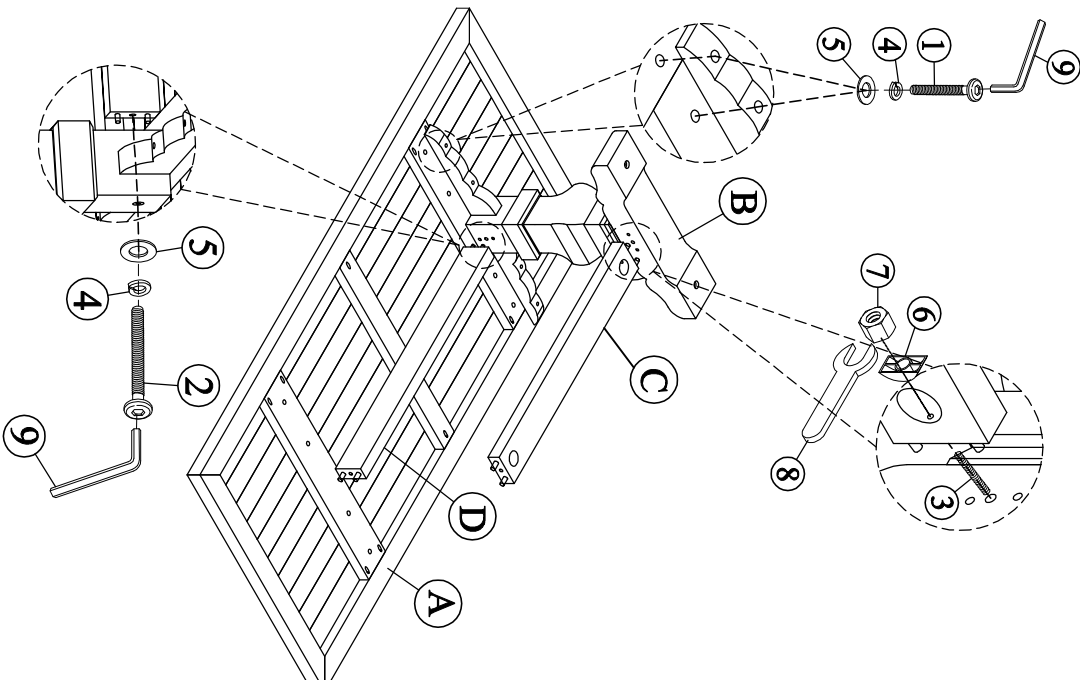

Step. 2

