

ASSEMBLY INSTRUCTIONS

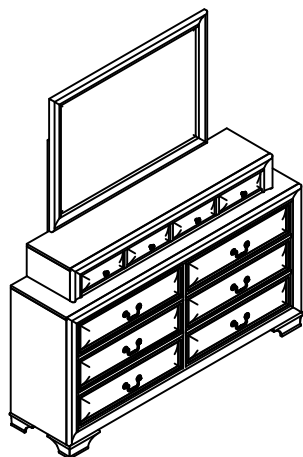

DRESSER

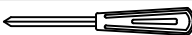

Caution: Please read instructions thoroughly before unpacking assembly parts. Sharp, exposed staple tips can cause injury, therefore, for your protection, please remove any exposed staple used in packing.

1. We recommend that you should assemble this product with the assistance of another person; this will make assembly easier, and will help to eliminate damage to the product or injury to persons during assembly.
2. Be sure to check all packing materials carefully for small parts that may have come loose inside the carton during shipment.
3. please do not over tighten screws or bolts.
4. Please put all parts on a non-abrasive floor before assembly, and follow the assembly steps to assemble your newly purchased product correctly and efficiently.



TOOLS REQUIRED (NOT PROVIDED)	
PHILLIPS SCREWDRIVER	

HARDWARE LISTS			
NO.	OUTLOOK	SIZE	Q'TY
A		JCBC bolt (1/4"*1-3/8"L)	8PCS
		Lock washer 1/4"	8PCS
		Flat washer 1/4"x19mm*1mm	8PCS
B		Allen key (4mm)	1PC
C		Tipping restraint	1SET

PART LISTS			
NO.	Sketch	Description	Q'TY
1		DRESSER	1PC
2		MIRROR	1PC
3		MIRROR SUPPORTS	2PCS

STEP 1

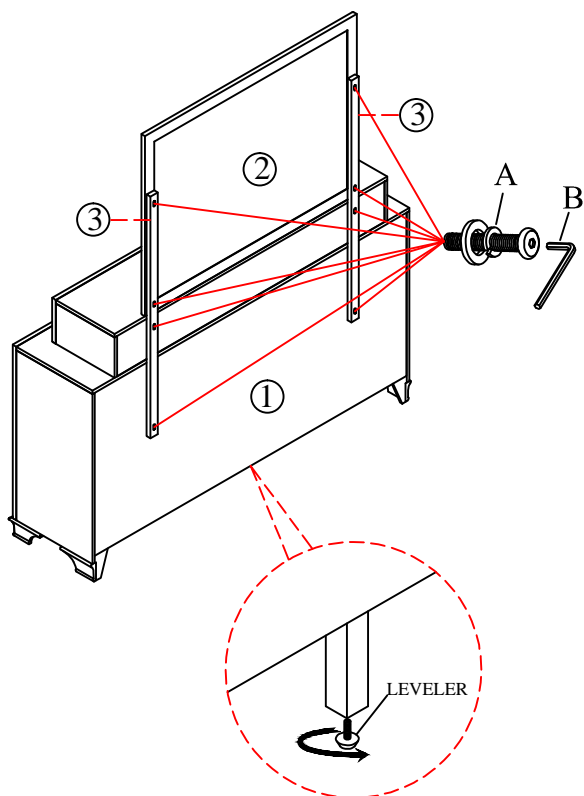

STEP 2

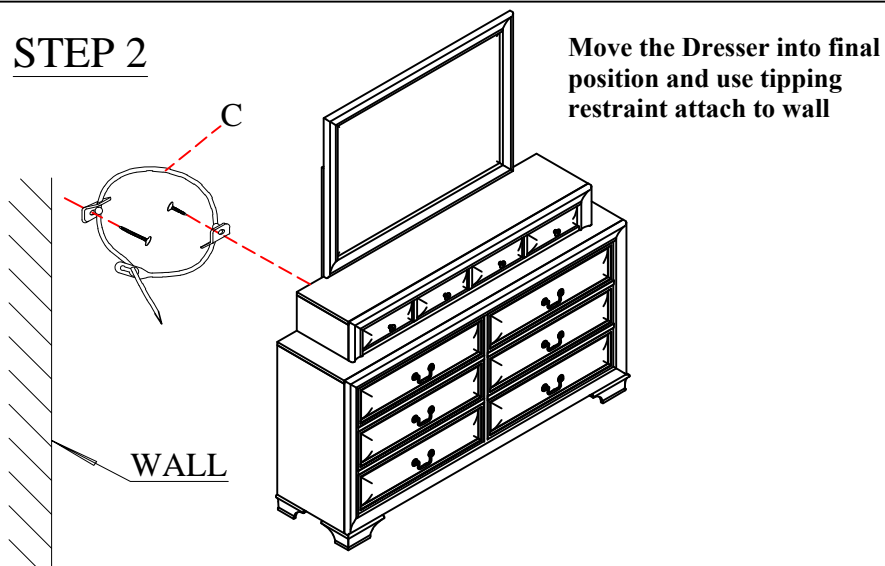

Completed

