

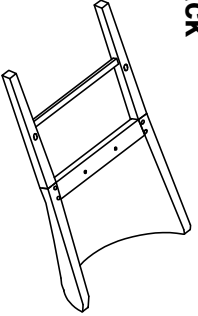

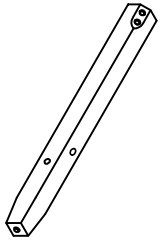
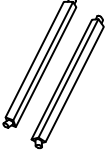

ASSEMBLY INSTRUCTIONS

Group name: NAPA
 Description: Counter Height Parson Chair
 Item No: TN-252-PCBP & TN-252-PCTP

PARTS LIST

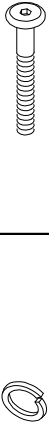
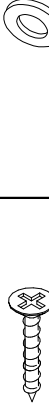
A Chair back			
		1 pc	
B Seat Frame	C Front legs		
		1 pc	
D Front stretcher	E Side stretcher		
		1L, 1R	
HARDWARE LIST			
1. Short bolt	2. Long bolt		
		1/4" x 40mm(2 pc)	
3. Long bolt	4. Spring washer		
		1/4" x 90mm(4 pcs)	
5. Flat washer	6. Screws		
		1/4" x 19(10 pcs)	
7. Allen key			
		4mm(1 pc)	

Step. 1

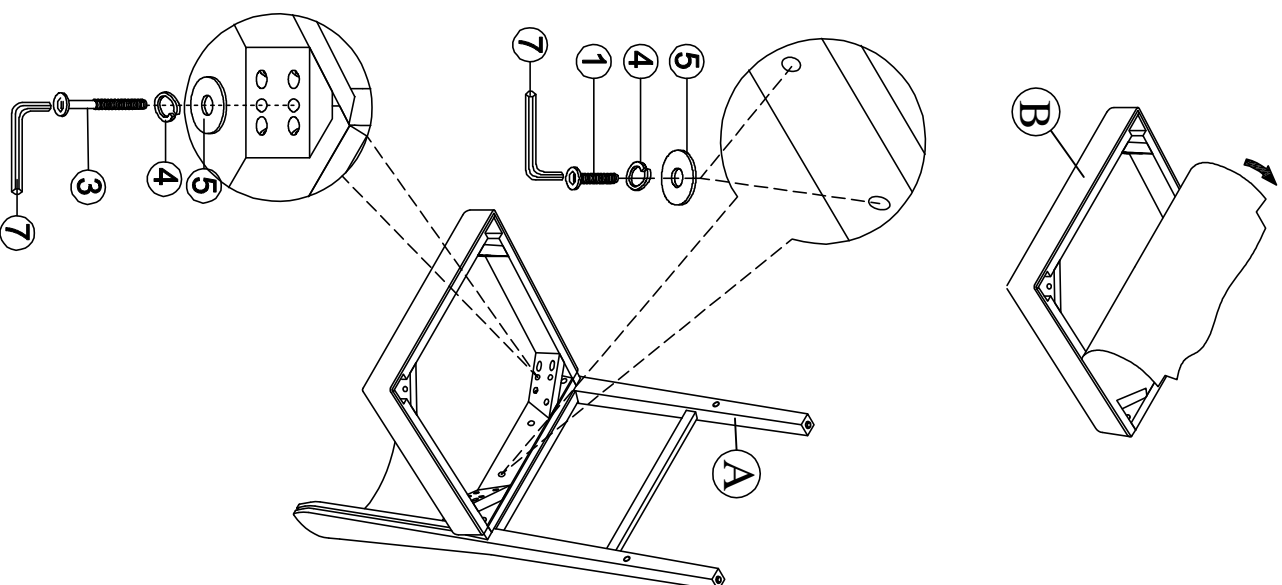

Step. 2

