

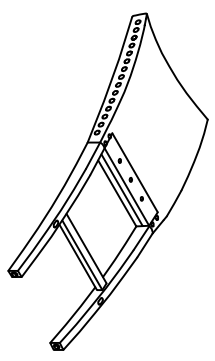

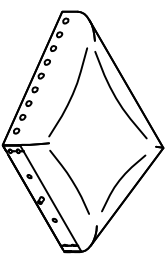
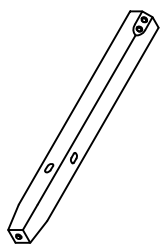
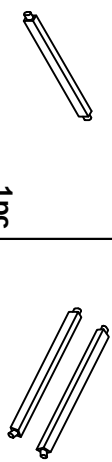
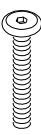
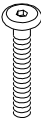
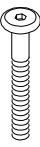

ASSEMBLY INSTRUCTIONS

Description: Dahlia Parson Pub Height Chair with Metal Nail
Item No: TN-110 -1PC

PARTS LIST

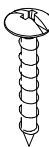
A Chair back			
B Seat Frame		C Front legs 1 pc	
			
D Front stretcher 1pc	E Side stretcher 1L, 1R		
HARDWARE LIST			
1. Short bolt 1/4" X 40mm(2 pc) 	2. Long bolt 1/4" X 60mm(4 pcs) 		
3. Long bolt 1/4" X 85mm(4 pcs) 	4. Spring washer 1/4" (10 pcs) 		
5. Flat washer 1/4" X 19(10 pcs) 	6. Screws #4 X 38mm(6 pcs) 		
7. Allen key 4mm(1 pc) 			

Step. 1

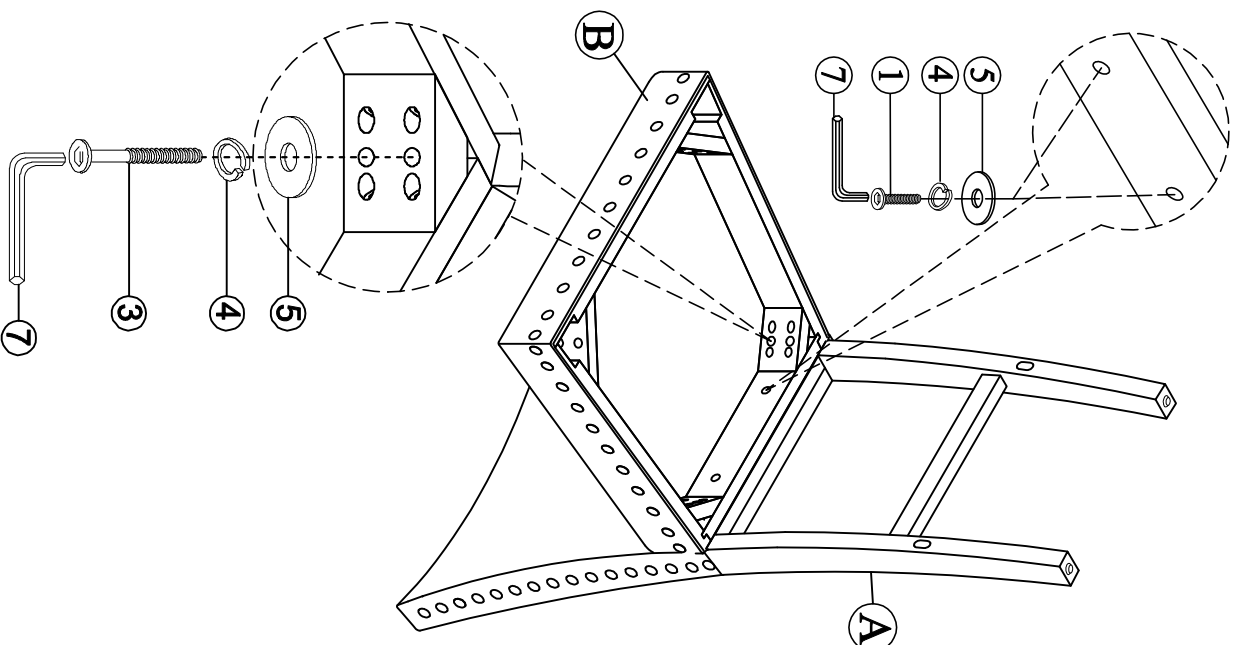

Step. 2

