

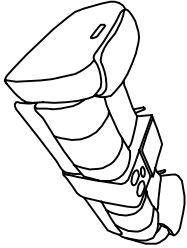



**ITEM : 6250-MLS**  
PARTS LIST

NO	DESCRIPTION	PART	QTY
A	SEAT		1pc
B	LEFT BACK		1pc
C	RIGHT BACK		1pc
D	CENTER BACK		1pc
E	HAND BOLT		2 pcs

**STEP 1**

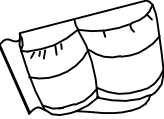
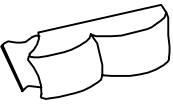
PLACE CENTER BACK ON AND ATTACH USING HAND BOLTS

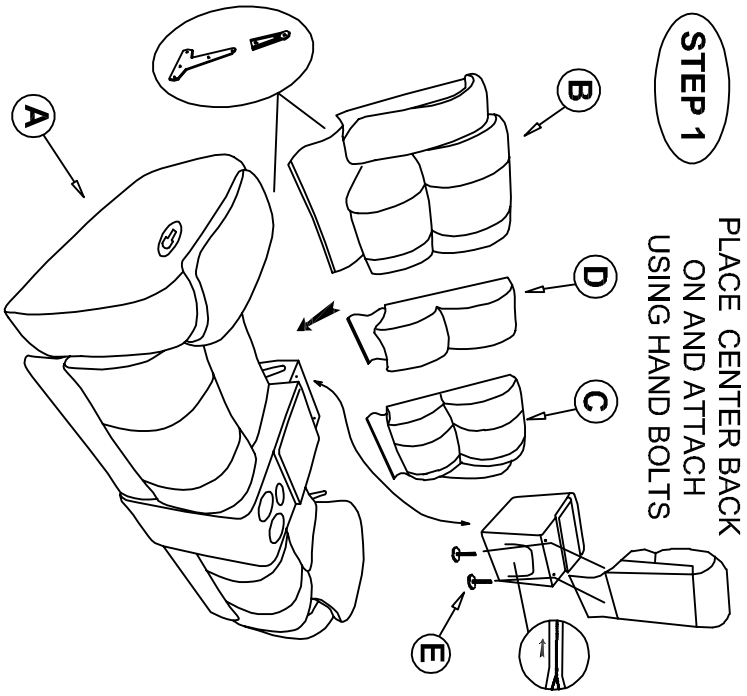

**STEP 2**

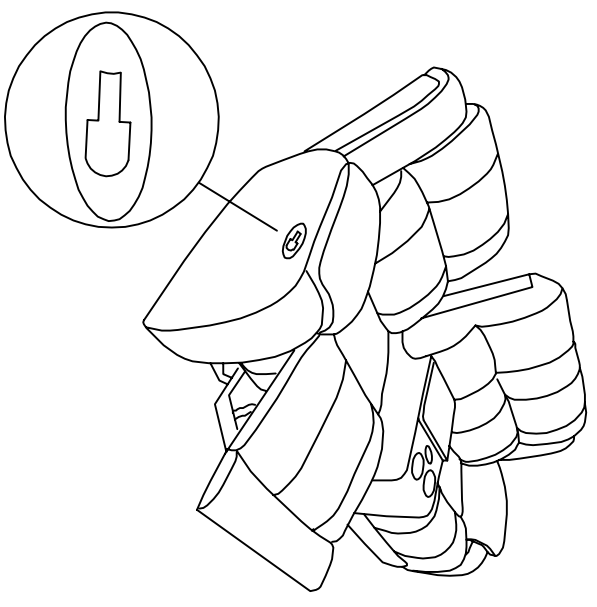

**FINISH**

