

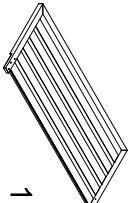

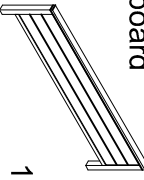







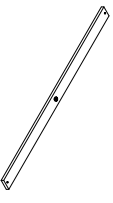

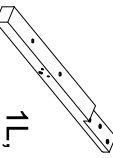

# ASSEMBLY INSTRUCTIONS

Description: QUEEN BED  
Item No: B007QHB+QFB+QSR

## LIST OF PARTS

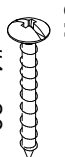
(A) Headboard  1 pc	(B) Footboard  1 pc
(C) Side rail  2 pcs	(D) Slats  5 pcs
(E) Support with leveler  5 pcs	(F) Headboard leg  1L, 1R
(G) Stretcher  1 pc	

## LIST OF HARDWARE

1. Bolts  5/16" x 83mm(8 pcs)	2. Washer  5/16"(8 pcs)
3. Nut  5/16"(8 pcs)	4. Spanner  5/16"(1 pc)
5. Screw  #4 x 30mm(10 pcs)	6. Washer  5/16"(8 pcs)
7. Spring washer  5/16"(8 pcs)	8. Bolts  5/16" x 45mm(8 pcs)
9. Allen key  4mm(1 pc)	

Step.1

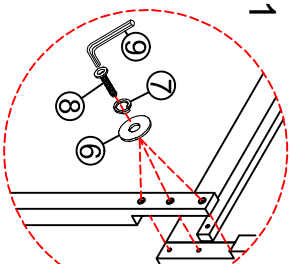

Step.2

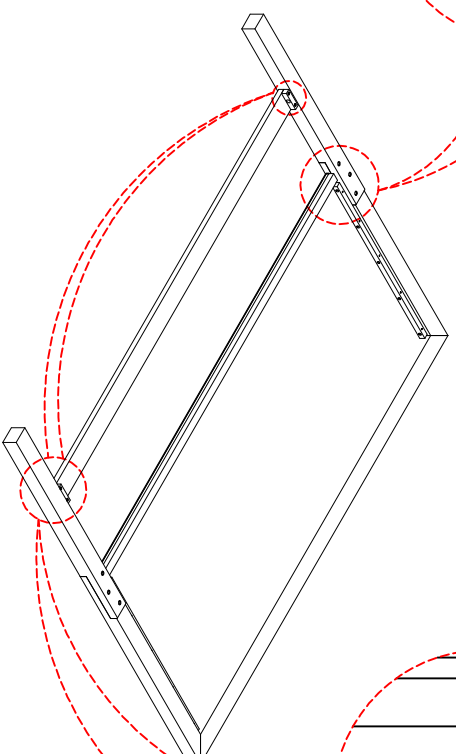
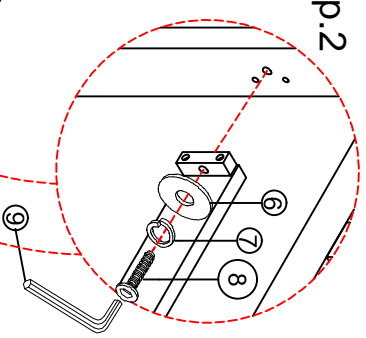

Step.3

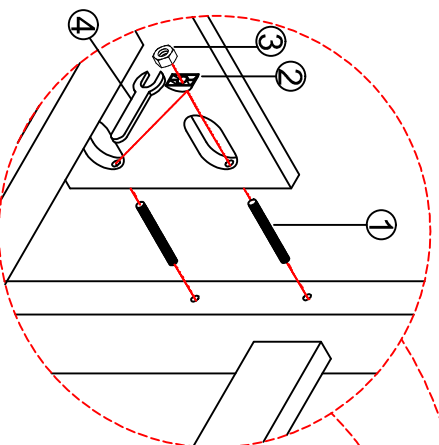

Step.4

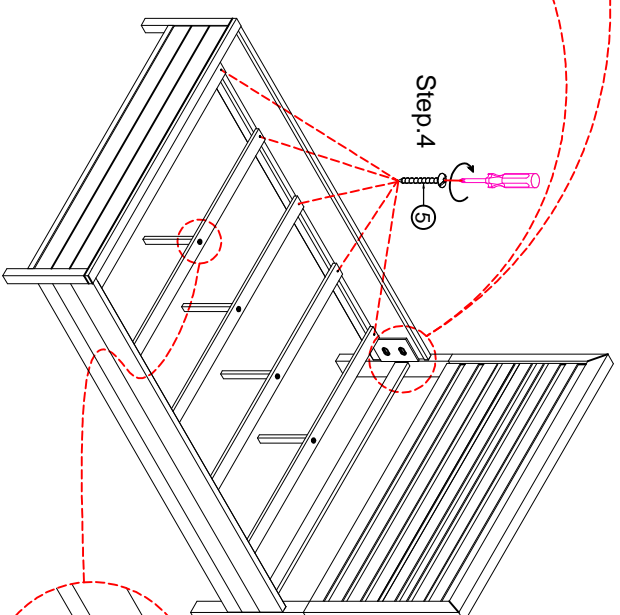
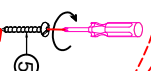

Step.5

