

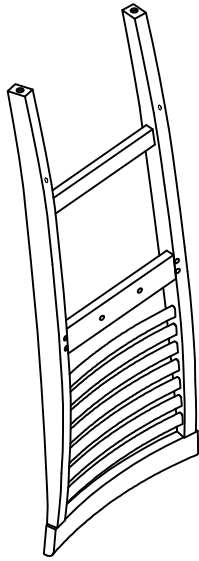

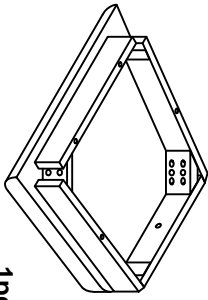



ASSEMBLY INSTRUCTIONS

Group name: **FREDRICK**
 Description: **Counter Height Chair**
 Item No: **TN-2745-CC**

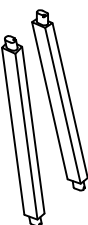
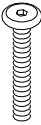
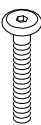
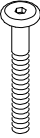
PARTS LIST

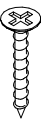
(A) Chair back 		
(B) Seat Frame 	(C) Front legs 	1 pc
(D) Front stretcher 	(E) Side stretcher 	1L; 1R
HARDWARE LIST		
1. Short bolt  1/4" x 35mm(2 pc)	2. Bolt  1/4" x 60mm(4 pcs)	
3. Long bolt  1/4" x 75mm(4 pcs)	4. Spring washer  1/4" x 12mm(10 pcs)	
5. Flat washer  1/4" x 19mm(10 pcs)	6. Screws  #4 x 38mm(6 pcs)	
7. Allen key  4mm(1 pc)		

Step. 1

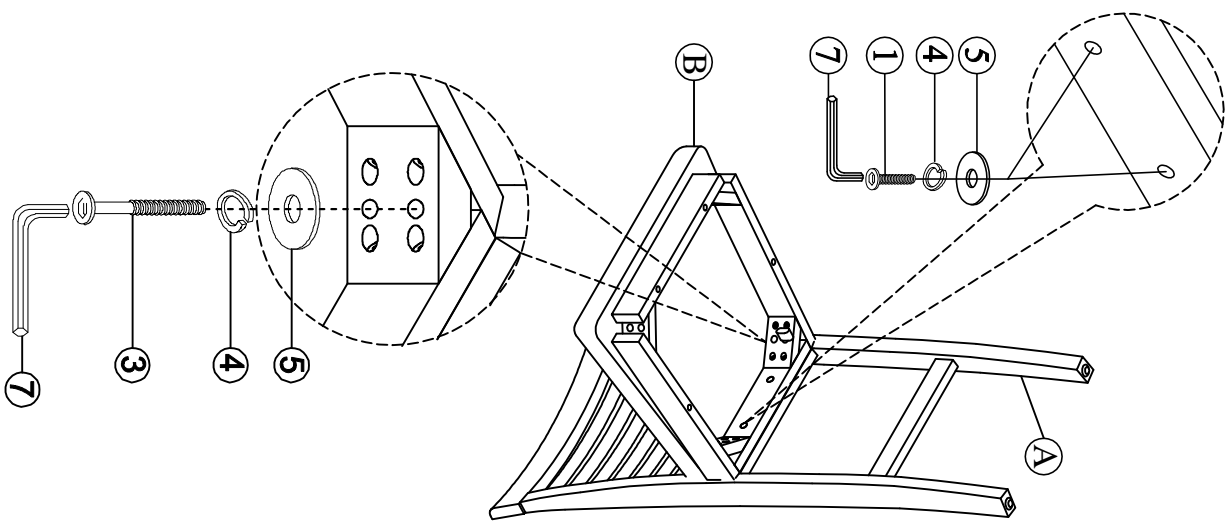

Step. 2

