

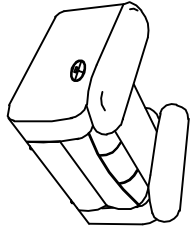



ITEM : 6130-MR

PARTS LIST

NO	DESCRIPTION	PART	QTY
A	SEAT		1pc
B	BACK		1pc
C	LEFT WING		1pc
D	RIGHT WING		1pc

STEP 1

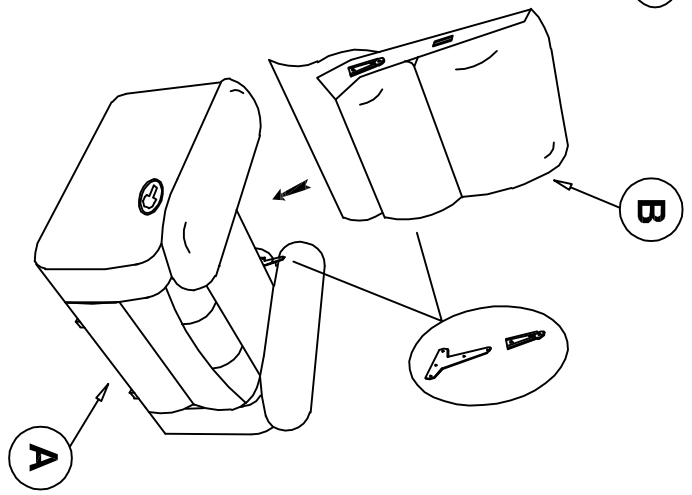

STEP 2

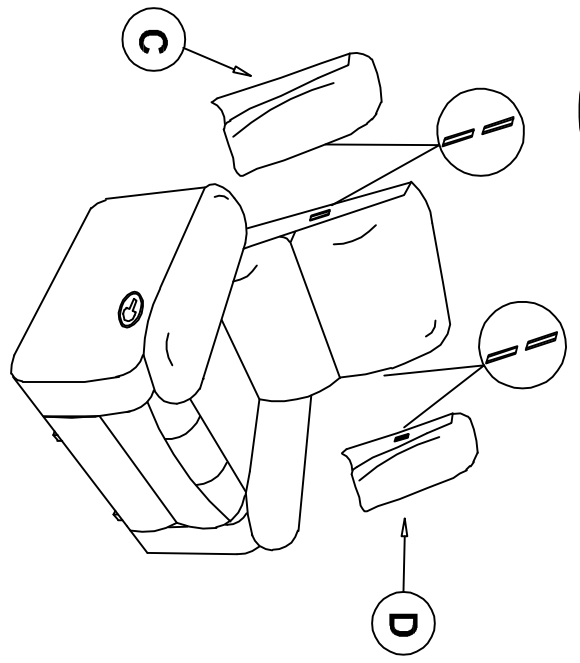

STEP 3

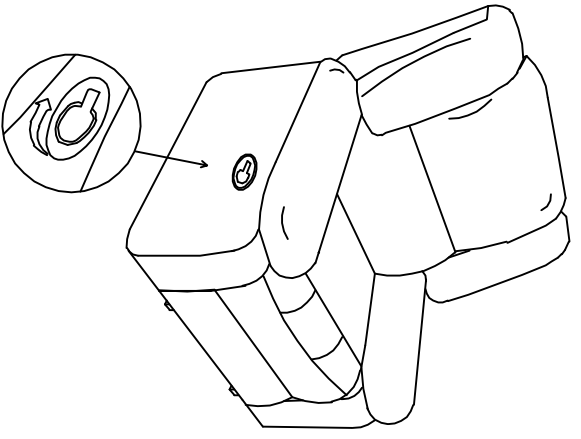

FINISH

