

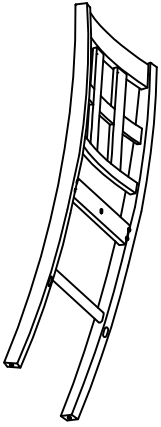

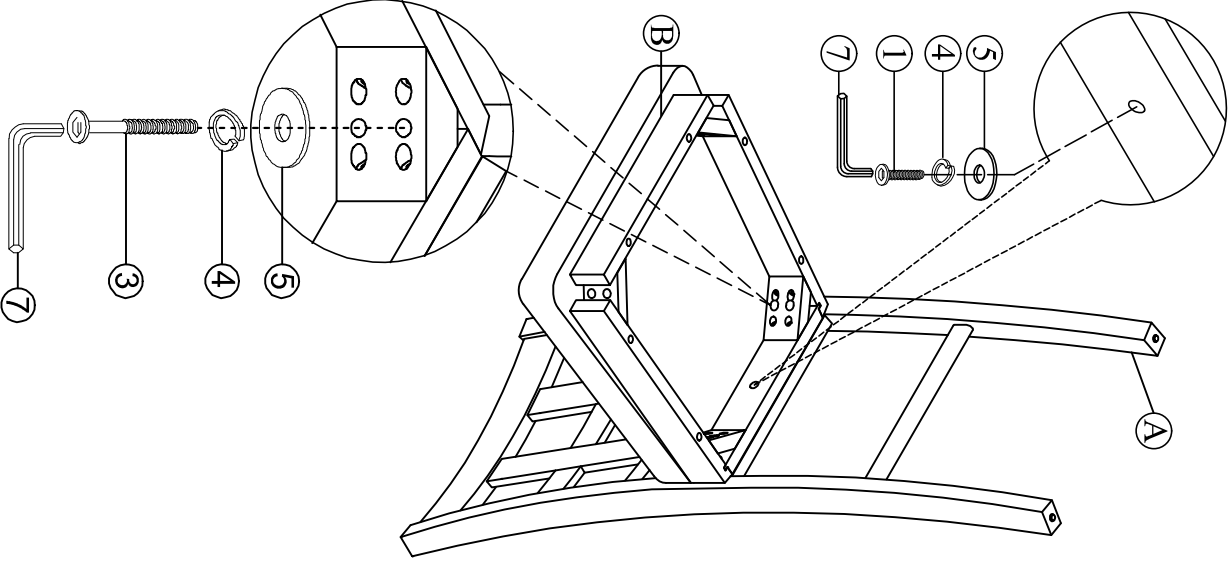

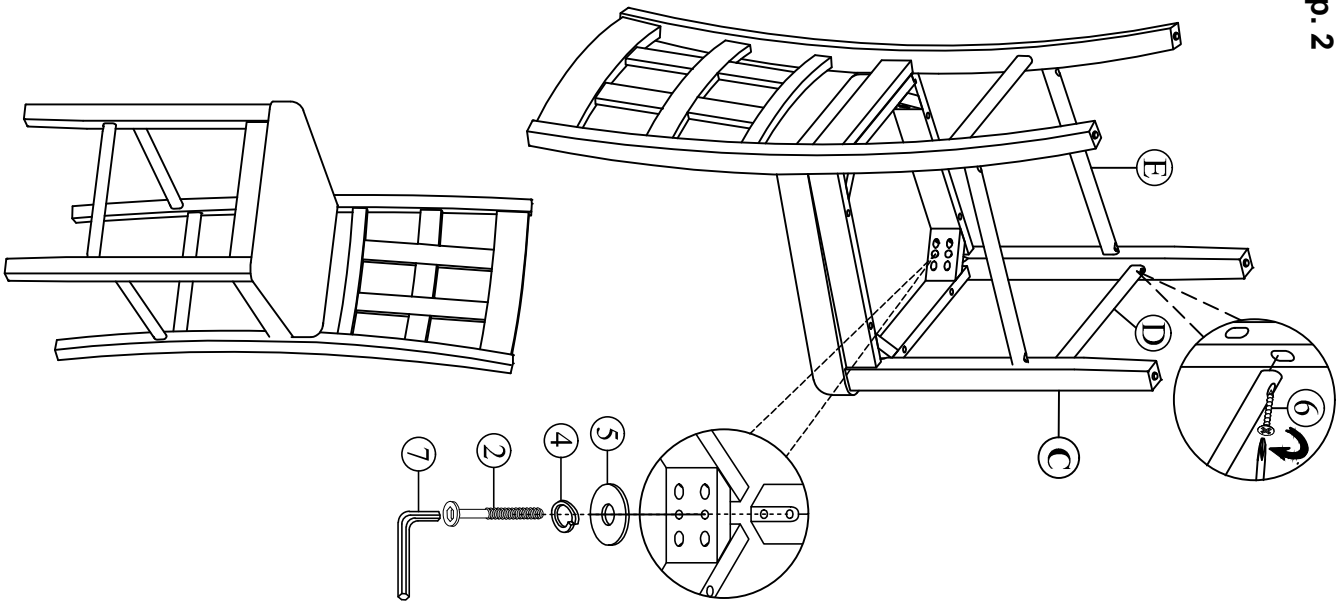

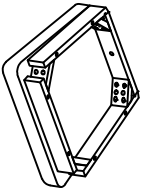

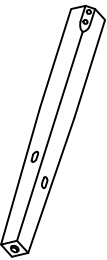
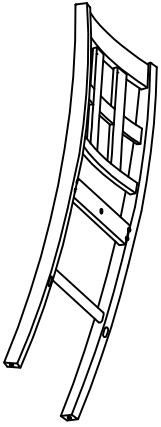
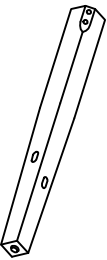

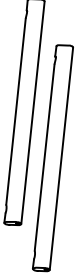
ASSEMBLY INSTRUCTIONS

Description: **CENTRAL PARK 7 5PC PACK PUB SET**
 Item No: TN-086P

PARTS LIST

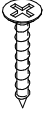
A Chair back		Step. 1	
			
B Seat Frame	C Front legs	Step. 2	
			
D Front stretcher	E Side stretcher		
			
1pc	1L; 1R		
HARDWARE LIST			
1. Short bolt	2. Long bolt		
 1/4" x 35mm (1 pc)	 1/4" x 60mm (4 pcs)		
3. Long bolt	4. Spring washer		
 1/4" x 75mm (4 pcs)	 1/4" (09 pcs)		
5. Flat washer	6. Screws		
 1/4" x 19 (09 pcs)	 #4 x 38mm (6 pcs)		
7. Allen key			
 4mm (1 pc)			

ASSEMBLY INSTRUCTIONS

Description: CENTRAL PARK 7 5PC PACK PUB SET
Item No: TN-086P

LIST OF PARTS

Step.1

(A) Top Table

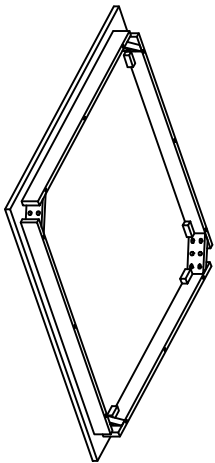

1pc

(B) Legs

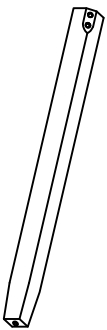

4pcs

LIST OF HARDWARE

Step.2

1. Flat Washer

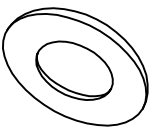

5/16" x 19mm(8pcs)

2. Spring Washer



5/16" (8pcs)

3. Long bolt

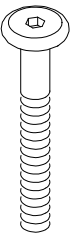

5/16" x 70mm(8pcs)

4. Allen key

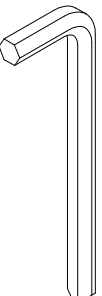

4mm(1 pc)

Step.1

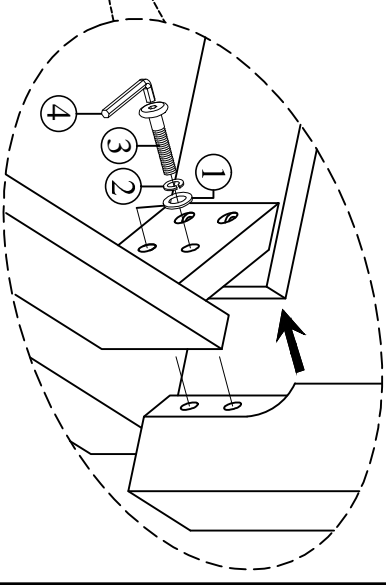
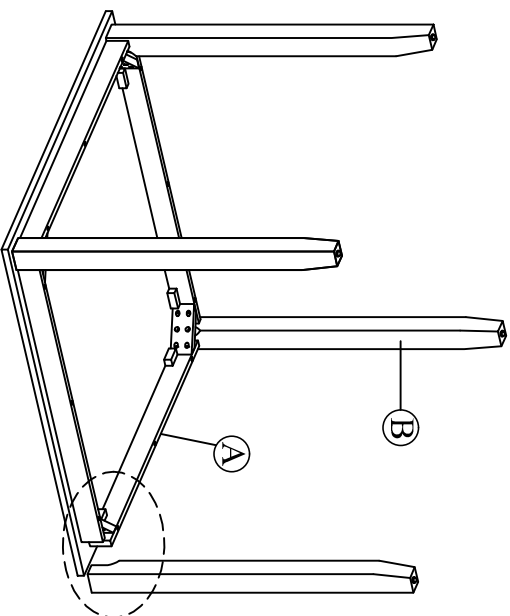

Step.2

