

ASSEMBLY INSTRUCTIONS

Description: CEDAR GROVE MIRROR
Item No: TN - B001M

LIST OF PARTS

(A) Mirror

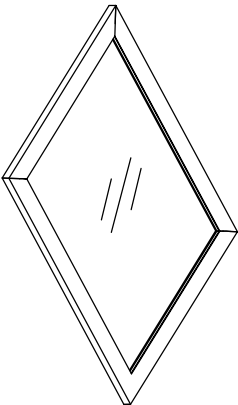

1pc

(B) Mirror support

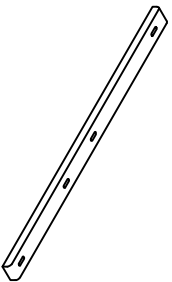

2pcs

Step. 1

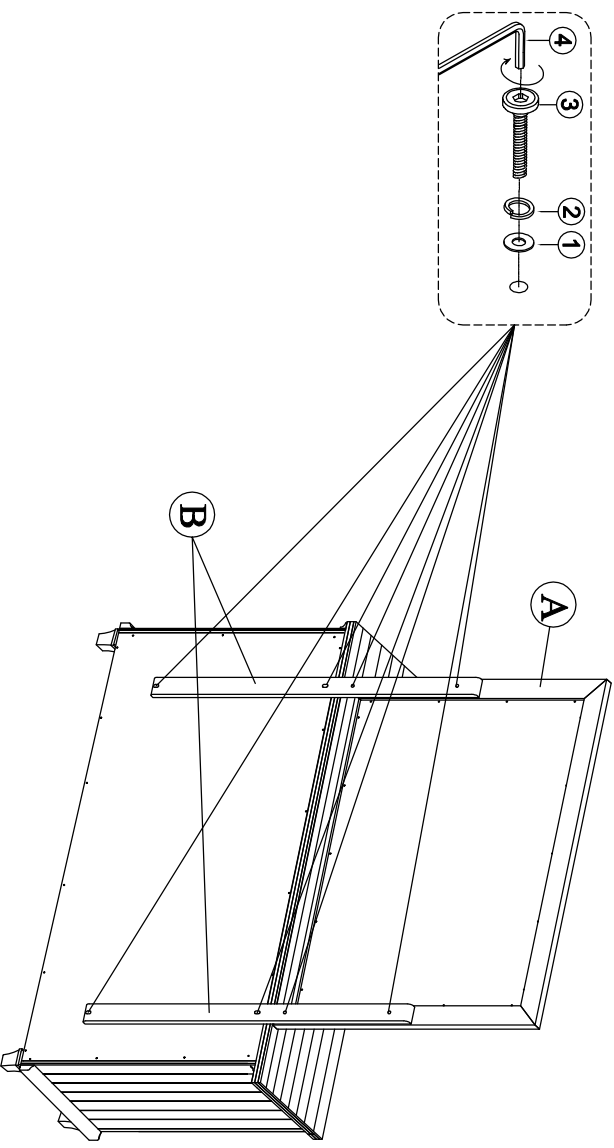

LIST OF HARDWARE

1. Flat Washer

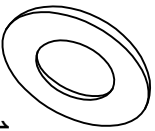

1/4" (8pcs)

2. Spring Washer



1/4" (8pcs)

3. Short bolt

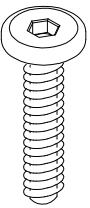

1/4" x 40mm(8pcs)

4. Allen key

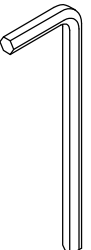

4mm(1 pc)

5. Anti - tip restraint

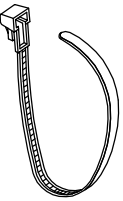

1 pc

Completed

