

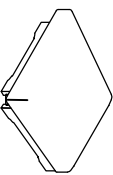

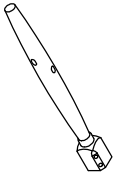

# ASSEMBLY INSTRUCTIONS

Group Name: Catherine  
 Description: Counter Chair  
 Item No: TN320-CC

## LIST OF PARTS

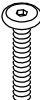
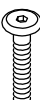
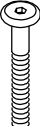
<b>(A) Chair back</b>		<b>1 pc</b>	
<b>(B) Seat Frame</b>	<b>(C) Front legs</b>	<b>1 pc</b>	
			
<b>(D) Front stretcher</b>	<b>(E) Side stretcher</b>	<b>1L; 1R</b>	
		<b>1L; 1R</b>	
<b>HARDWARE LIST</b>			
<b>1. Short bolt</b>	<b>2. Medium bolt</b>		
 1/4" x 40mm(2 pcs)	 1/4" x 60mm(4 pcs)		
<b>3. Long bolt</b>	<b>4. Spring washer</b>		
 1/4" x 75mm(4 pcs)	 1/4" (10 pcs)		
<b>5. Flat washer</b>	<b>6. Screws</b>		
 1/4" x 19(10 pcs)	 #4 x 38mm(6 pcs)		
<b>7. Allen key</b>			
 4mm(1 pc)			

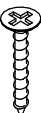
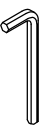
### Step. 1

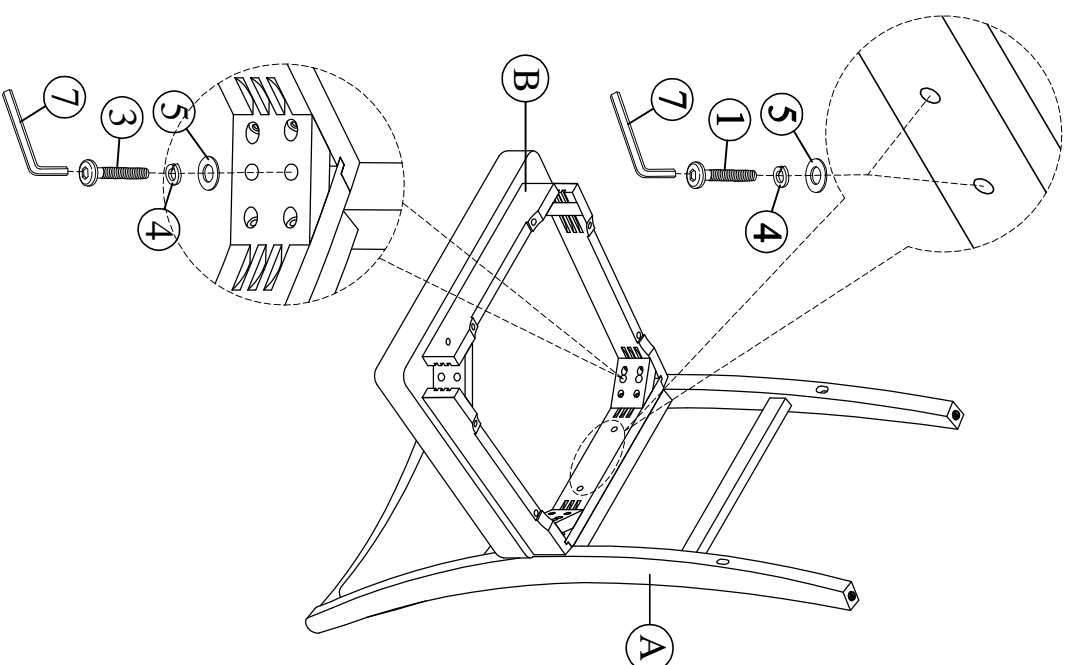

### Step. 2

