

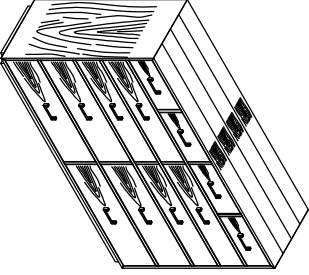





ASSEMBLY INSTRUCTIONS

Group Name: CARMEN 2
 Description: Dresser
 Item No: TN-455-DR

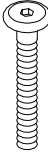
LIST OF PARTS

A. Dresser			
		1pc	
B. Legs		C. Mid Legs	
		4pcs	
HARDWARE LIST			
1. Bolt		2. Spring washer	
5/16" x 45mm(6 pcs)		5/16" (6 pcs)	
3. Flat washer		4. Allen key	
5/16" (6 pcs)		4mm (1 pc)	
5. Tipping Restraint			
		(1 set)	

Step. 1

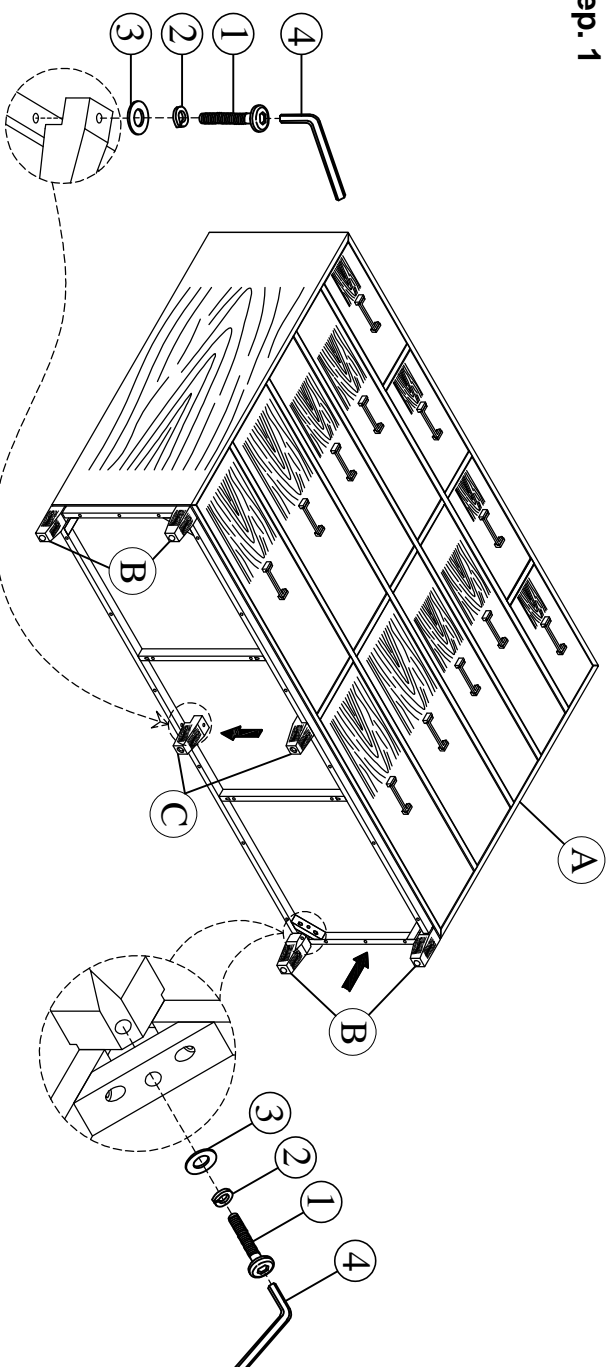

Completed

