

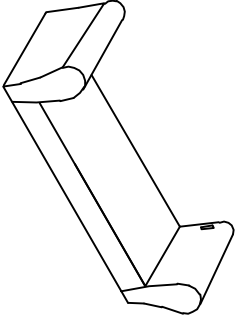

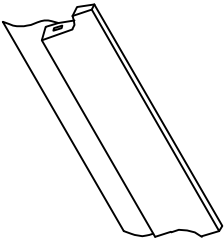

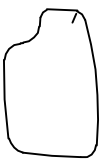

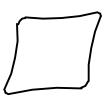

ITEM : 4523-S
PARTS LIST

NO	DESCRIPTION	PART	QTY
A	SEAT		1pc
B	BACK		1pc
C	LEFT, RIGHT BACK PILLOW		2pcs
D	CENTER BACK PILLOW		1pc
E	THROW PILLOWS		4pcs
F	KIDNEY PILLOW		1pc
G	LEFT, RIGHT, CENTER CUSHION		3pcs
H	LEGS		4pcs
I	BOLTS		4pcs
J	ALLEN KEY		1pc

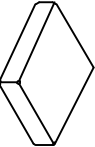
STEP 1

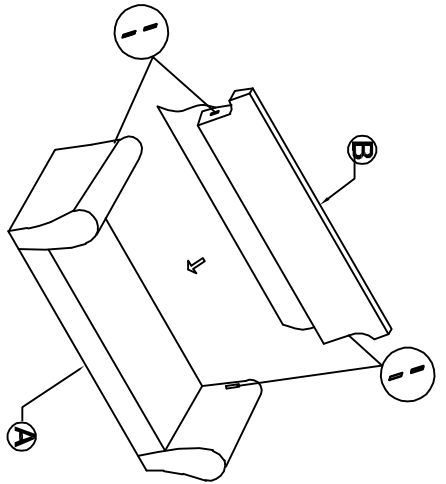

STEP 2

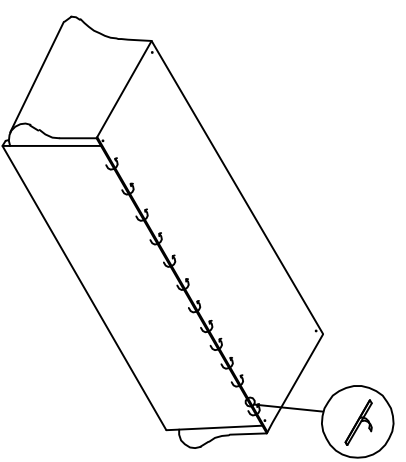

STEP 3

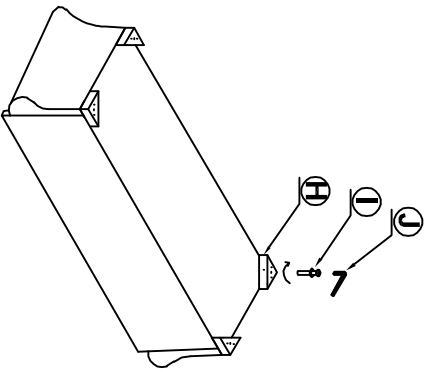

FINISH

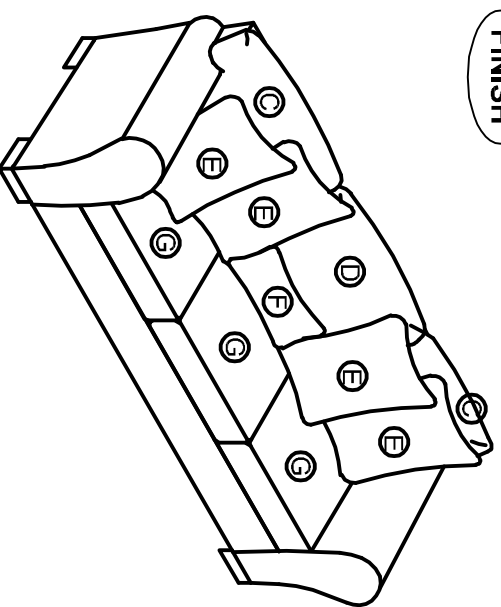

Please Check Underneath Seat Deck For Any Parts That May Be Inside